



MegaMc  
No.1236



TracStar 900

**No.1236**

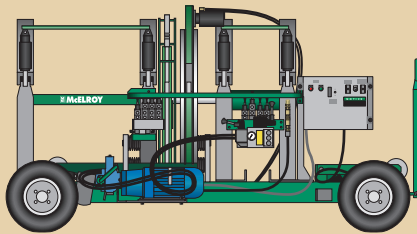

**TracStar 900**

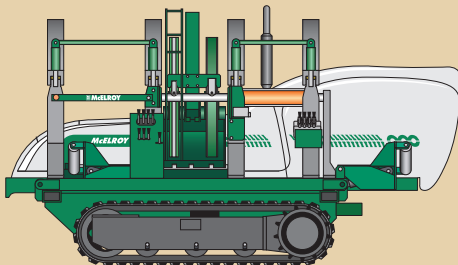

**No.1236/900**



## MegaMc® No.1236 & TracStar® 900

machines will butt fuse pipe sizes from 12" IPS – 36" OD (340mm – 900mm). The machine allows for butt fusion of most fittings without special holders or removal of the outer jaw. Mitered inserts are available for fabricating ells. McElroy's unique semi-automatic control system requires only one operator. Hydraulic power assists all fusion functions including the complete operation of the jaws, pipe lifts, heater, and facer. Both machines incorporate McElroy's patented Centerline Guidance System. The standard manifold No.1236 is DataLogger® compatible.

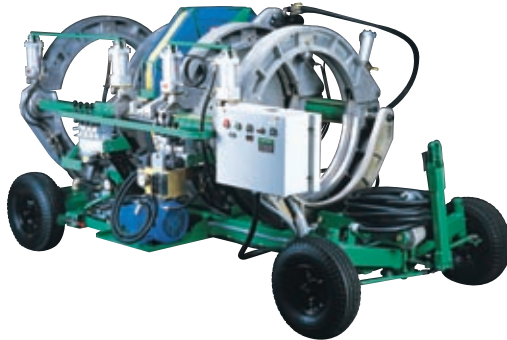

- The optional Coach™ fusion control system controls the hydraulics, heater temperature, and allows for on-machine operation or remote operation. It is programmable for multiple pressure set points and performs pressure calculations, with drag compensation and more. An integral data logging feature is standard.



### MegaMc® No.1236

- Hydraulic Power Assist
- Centerline Guidance System
- On-board generator for powering heater and other devices
- DataLogger® compatible



### TracStar® 900

- Track mounted, self-contained, self-propelled, all-terrain
- On-board generator for powering heater and other devices
- The jawset/carriage can be easily removed from the chassis for in-ditch use
- Optional Coach™ fusion control system



Featuring a wireless remote control for precision placement, and optimum visibility on the job site.

Patent No's. 5,814,182 6,212,748 6,212,747 6,021,832 (other patents pending)

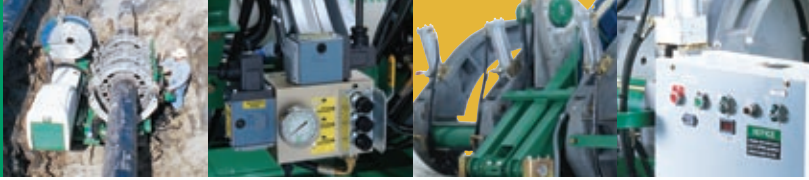

## No.1236 Fusion Machines

Package includes: fusion machine, facer, heater, butt fusion heater adapter set, lifting assembly, and operator's manual.

220-240V, 50/60Hz, 3 Ph	Part No.
High Force Cylinders	<b>A3600712</b>
Medium Force Cylinders	<b>A3600711</b>
Low Force Cylinders	<b>A3600713</b>

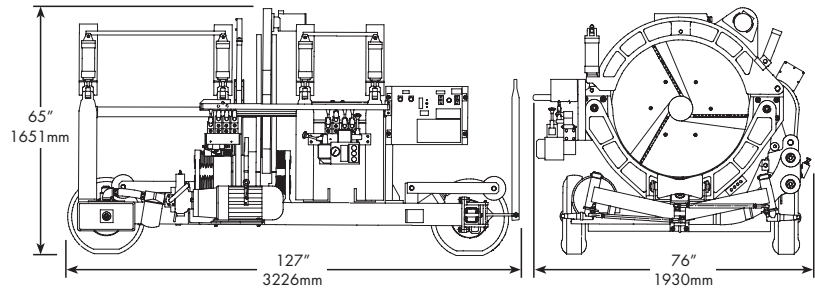

**weight** 4,500lbs (2041Kg) **input power** 30 KVA

**CYLINDERS** For information on cylinder force selection. Please see page **32-5**

## TracStar® 900 Fusion Machines

Package includes: fusion machine, facer, heater, remote control with batteries & 12V charger, lifting assembly, and operator's manual. Download cable included with Coach Equipped package.

Description	Part No.
Coach Equipped Medium Force Cylinders	<b>AT9000101</b>
Description	Part No.
Standard Manifold High Force Cylinders	<b>AT9000102</b>
Standard Manifold Medium Force Cylinders	<b>AT9000103</b>
Standard Manifold Low Force Cylinders	<b>AT9000104</b>

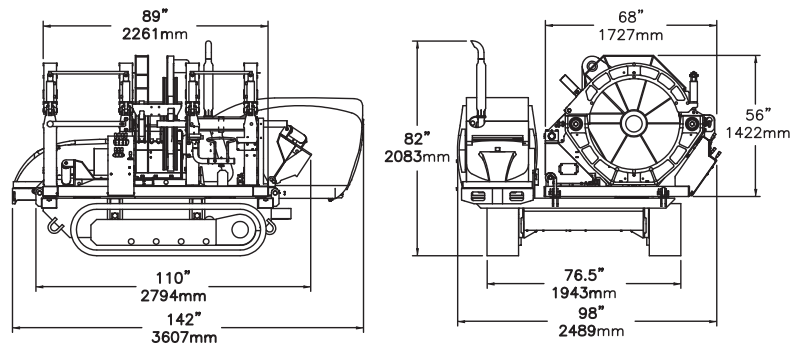

**weight** 9,300lbs (4218Kg) **diesel** - Self-Contained

**No.1236/900**

## No.1236/900 Accessories:

● **TracStar 900 Coach Equipped**

### Spare Butt Plate Kit

Heater adapters have an anti-stick coating and are required for butt fusion.

Description	Part No.
Kit = 2 Adapter Plates	<b>A3617201</b>



Includes attaching screws.

### Stub End Holder

Holds stub end for butt fusion.

Description	Part No.
Holder	<b>3606901</b>



### Spare Facer Blades

Description	Part No.
Set = 6 Blades	<b>3615707</b>

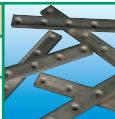

### Pipe Support Stand

Height is adjustable to properly support, position and align pipe to be fused.

Description	Part No.
Support Stand	<b>T9017401</b>
Heavy Duty Stand	<b>4823901</b>





**DataLogger Compatible**  
A handheld computer used to document the profile of each fusion joint. See page 28-1.

### Pyrometer Kit

Pyrometer kit for accurately checking surface temperatures of heater.

Description	Part No.
Digital Meter	<b>A218803</b>



### Coach Download Cable

Description	Part No.
Spare Download Cable ●	<b>T5016901</b>
Download AC Adapter ●	<b>T5029001</b>



### In-Ditch Extension Kit

40' hydraulic hoses, and extension cord for pendant and heater.

Description	Part No.
Coach Extension Kit ●	<b>T9002001</b>
Extension Kit	<b>T9002002</b>



### Spare Remote Battery

Description	Part No.
Remote Battery	<b>MKG00023</b>
12VDC Charger	<b>MKG00024</b>
120/220 VAC Charger	<b>MKG00025</b>



### Coach System Printer

Description	Part No.
120V, 60Hz, 1Ph ●	<b>DL3801</b>
220V, 50Hz, 1Ph ●	<b>DL3802</b>
Printer Cable ●	<b>T5022001</b>



### Coach System Spares

Description	Part No.
Pendant (shown) ●	<b>T5007101</b>
Control Box ●	<b>T5001801</b>



## Butt Fusion Inserts

Inserts are made for one size pipe only and are required for pipe sizes less than 36" OD. Not all inserts fit directly in the jaws. Some inserts nest inside other inserts, called master inserts.

**Set = 8 Inserts**

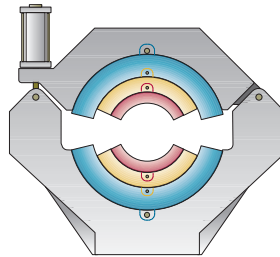

## Cast Fabricated

VERSUS

## Cast Inserts

Cast inserts are made from a high strength aluminum alloy, for light weight and easy handling, and have been surface hardened for longer life. All inserts are serrated for maximum grip on the pipe.

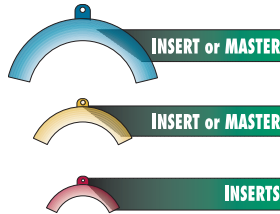

## Fabricated Inserts

Fabricated inserts are constructed out of precision laser cut carbon steel and rolled components to ensure proper alignment in the jaws. They are normally lighter in weight than cast inserts.

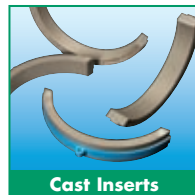

**NOTE:** Other sizes of inserts are available upon request. Contact your McElroy representative about inserts to fit your needs.

### All inserts below fit in 36" jaws

Inserts	Pipe OD	Cast Set #	Fab. Set #
<b>36" JAW</b>	36.00 (914mm)	N/R	N/R
900mm	35.43 (900mm)	N/A	3629401
34" OD	34.00 (864mm)	3603532	N/A
32" OD	32.00 (813mm)	3603512	3629501
800mm	31.50 (800mm)	3603509	3629601
30" OD	30.00 (762mm)	3603515	3629701
28" OD	28.00 (711mm)	3603418	3619705
26" OD	26.00 (660mm)	3606614	3629801
24" DIPS	25.80 (655mm)	3606617	3629901
<b>630mm Master</b>	24.80 (630mm)	3606604	N/A

### All inserts below require 630mm Master insert

Inserts	Pipe OD	Cast Set #	Fab. Set #
24" OD	24.00 (610mm)	2411604	2402301
22" OD	22.00 (560mm)	2411919	N/A
20" DIPS	21.60 (549mm)	2411922	N/A
20" OD	20.00 (508mm)	2412010	N/A
500mm	19.69 (500mm)	2412011	N/A
18" DIPS	19.50 (495mm)	2412023	N/A
<b>18" Master</b>	24.80 (630mm)	3606604	N/A

### All inserts below require 630mm & 18" Master inserts

Inserts	Pipe OD	Cast Set #	Fab. Set #
450mm	17.72 (450mm)	N/A	2418201
16" DIPS	17.40 (442mm)	2412117	2418301
16" OD	16.00 (406mm)	2412110	N/A
400mm	15.75 (400mm)	2412111	N/A
14" DIPS	15.30 (389mm)	2412215	N/A
14" OD	14.00 (355mm)	2412206	N/A
340mm	13.39 (340mm)	2411811	N/A
12" DIPS	13.20 (335mm)	2411826	N/A
<b>12" Master</b>	12.75 (324mm)	2411810	N/A

## No.1236/900 Accessories:

### Mitered Inserts



Used to fabricate segmented ells. Inserts are made for one size pipe only. Some inserts nest inside other inserts, called master inserts.

**Set = 4 Inserts + 1 Template**

**NOTE:** Other sizes and angles of mitered inserts are available upon request. Contact your McElroy representative about inserts to fit your needs.

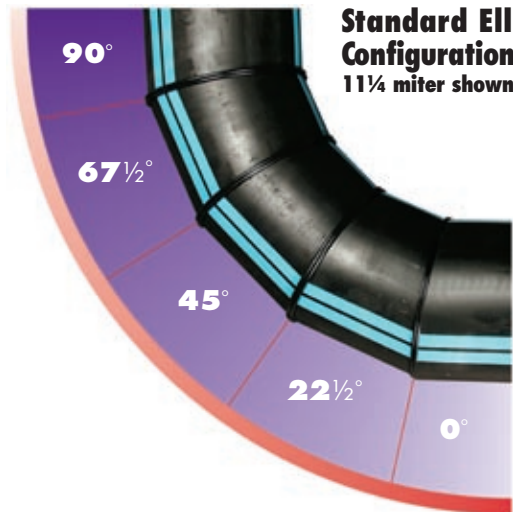
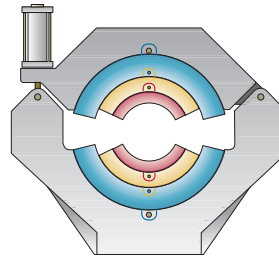

### All inserts below fit in 36" jaws

Inserts	Pipe OD	Cast Set #	Fab. Set #
32" OD x 1 1/4	32.00 (813mm)	3603526	3631601
800mm x 1 1/4	31.50 (800mm)	3603523	3630201
30" OD x 1 1/4	30.00 (762mm)	3603520	3631701
28" OD x 1 1/4	28.00 (711mm)	3603529	3631801
26" OD x 1 1/4	26.00 (660mm)	3606623	N/A
24" DIPS x 1 1/4	25.80 (655mm)	3606620	N/A
24" OD x 1 1/4	24.00 (610mm)	3606613	N/A
630mm <b>Master</b>	24.80 (630mm)	3606604	N/A

### All inserts below require 630mm Master insert

Inserts	Pipe OD	Cast Set #	Fab. Set #
20" DIPS X 1 1/4	21.60 (549mm)	2421257	N/A
20" OD X 1 1/4	20.00 (508mm)	2421217	N/A
18" DIPS X 1 1/4	19.50 (495mm)	2421251	N/A
18" OD X 1 1/4	18.00 (457mm)	2421215	N/A
16" DIPS X 1 1/4	17.40 (442mm)	2421245	N/A
18" <b>Master</b>	18.00 (457mm)	2411708	N/A

### All inserts below require 630mm & 18" Master inserts

Inserts	Pipe OD	Cast Set #	Fab. Set #
16" OD X 1 1/4	16.00 (406mm)	2420619	N/A
14" DIPS x 1 1/4	15.30 (389mm)	24206122	N/A
14" OD X 1 1/4	14.00 (355mm)	2420617	N/A
12" DIPS X 1 1/4	13.20 (335mm)	24206110	N/A
12" IPS X 1 1/4	12.75 (324mm)	2420615	N/A